

# AGL Reference Hardware Specification Document

2019/7/25 Ver 0.2.4

Change History

Version	Date	
0.1.0	2017/10/18	The first edition
0.2.0	2019/4/19	Revised for Step2
0.2.1	2019/4/25	Add section of "5.1. AGL Latest Stable Release Support"
0.2.2	2019/5/7	Add section of "5.6. Software specification"
0.2.3	2019/7/16	3.2. Add explanation what kind of interface should be open.
0.2.4	2019/7/25	Modify "3. AGL Reference Hardware requirements"

Index

1.	AGL Reference Hardware overview .....	5
1.1.	Goals of AGL Reference Hardware .....	5
1.2.	Glossary of Terms .....	6
2.	System Architecture .....	7
2.1.	Overview .....	7
2.2.	Use Case.....	8
2.3.	Major policy .....	9
2.4.	Major feature.....	10
2.4.1.	Selectable and Interchangeable architecture .....	10
2.4.2.	Open Interface.....	10
2.4.3.	Vehicle mountable structure.....	11
2.5.	Optional Feature.....	12
2.5.1.	Selector.....	12
2.5.1.1.	AV control device.....	12
2.5.1.2.	Location of peripheral devices .....	14
3.	AGL Reference Hardware requirements .....	15
3.1.	Selectable and Interchangeable Architecture .....	16
3.2.	Open Interface.....	17
3.3.	Vehicle mountable structure .....	17
4.	Peripheral devices and functional requirements .....	18
4.1.	Video / Audio input peripherals .....	18
4.1.1.	Camera.....	18
4.1.2.	Optical drive.....	18
4.1.3.	Tuner.....	19
4.1.4.	Microphone .....	19
4.2.	Video / Audio output peripherals.....	19
4.2.1.	Display .....	19
4.2.2.	RSE .....	20
4.2.3.	Cluster / HUD.....	20
4.2.4.	AMP / Speaker .....	21
4.3.	Data communication peripherals.....	21
4.3.1.	Vehicle External Network devices .....	21
4.3.1.1.	DCM / TCU .....	21
4.3.1.2.	Wi-Fi / Bluetooth® .....	22

4.3.1.3. USB.....	22
4.3.1.4. ETC / DSRC .....	22
4.3.1.5. NFC.....	22
4.3.2. Vehicle Internal Network devices.....	22
4.3.2.1. Vehicle Network .....	23
4.3.2.2. IVI Network.....	23
4.3.2.3. Vehicle signal .....	23
4.4. Other peripherals .....	23
4.4.1. Human Input devices.....	23
4.4.2. Navigation sensor .....	24
4.4.3. USB / SD (Media Storage).....	24
5. AGL software requirements .....	25
5.1. AGL Latest Stable Release Support.....	25
5.2. Selectable and Interchangeable architecture Support .....	25
5.3. Selector Support .....	25
5.4. Vehicle Data Abstraction .....	25
5.5. Cluster / HUD Support .....	26
6. Notices.....	27
7. [Appendix] step2 initial specificationエラー! ブックマークが定義されていません。 ん。	
7.1. Selectable and Interchangeable Architecture ...エラー! ブックマークが定義 されていません。	
7.2. Open Interface.....エラー! ブックマークが定義されていません。	
7.3. Vehicle mountable structureエラー! ブックマークが定義されていません。	
7.4. Hardware specification.....エラー! ブックマークが定義されていません。	
7.5. Software specification .....	エラー! ブックマークが定義されていません。

## **1. AGL Reference Hardware overview**

### **1.1. Goals of AGL Reference Hardware**

This document defines the specification of the Automotive Grade Linux (AGL) Reference Hardware.

The goals of the AGL Reference Hardware are :

- Defining the scope of peripherals which should be supported by AGL.
- Building Reference Hardware, System Architecture to deal with various requirements from OEMs.
- Reducing the gap of AGL community hardware and product hardware.

## 1.2. Glossary of Terms

Table 1 Glossary of Terms

Term	Definition
Must	It indicates requirement levels. It means that the definition is an absolute requirement of the specification
Should	It indicates requirement levels. It means that there may be valid reasons in particular circumstances to ignore a particular item, but the full implications must be understood and carefully weighed before choosing a different course.
Optional	It indicates requirement levels. It means that an item is truly optional.
AGL	Automotive Grade Linux
BD	Blu-ray Disc
DCM	Data Communication Module
HAL	Hardware Abstraction Layer
HMI	Human Machine Interface
HU	Head Unit
HUD	Head-Up Display
IVI	In-Vehicle Infotainment
NFC	Near Field Communication
RSE	Rear Seat Entertainment
SoC	System on a Chip
TCU	Telematics Communication Unit

## 2. System Architecture

### 2.1. Overview

There are multiple OEMs with each having a variety of cars. This creates a wide variety of types and combinations of peripheral devices connecting to the head unit. AGL UCB needs to be able to operate on multiple IVI system configurations. For example, AGL should support the various In-Vehicle Infotainment (IVI) systems, such as two different systems are shown in the Figure 1.

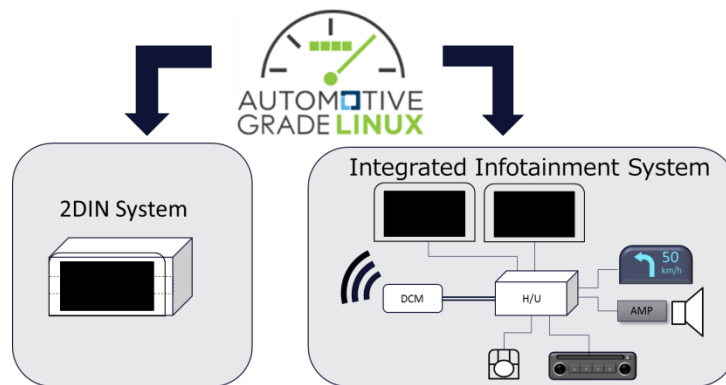

Figure 1 AGL should support two different systems

## 2.2. Use Case

The assumed Use Cases of the AGL reference hardware are following:

1. User: AGL community
  - UCB development and official demo
2. User: Institute/Tier2
  - Advanced research using vehicles
  - Product proposal (HW parts, cockpit)
  - Service proposal
  - Development tools
3. User: OEM/Tier1
  - Prior evaluation of the new generation communication Module
  - Performance evaluation with the SoC exchange

As mentioned section 1.1, one of the goals of the AGL reference hardware is to reduce the gap between the AGL reference hardware and product hardware (Figure 2).

Therefore it needs to reduce the gap assuming the product for the above Use Cases.

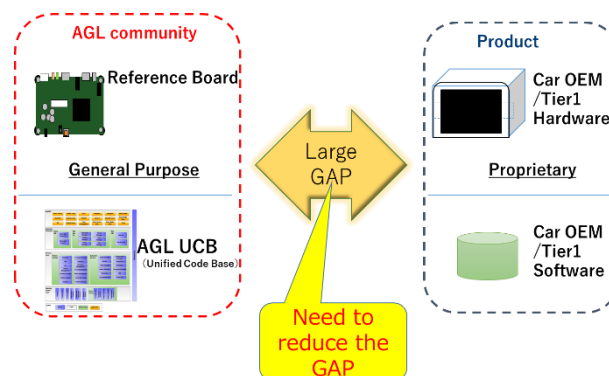

Figure 2 Need to reduce the gap between the AGL reference hardware and product hardware



## 2.3. Major policy

The major policies of the AGL Reference Hardware are following:

(1) SoC and peripherals are selectable and Interchangeable

The AGL Reference Hardware should adopt the diversification of IVI system configuration. So it should support many variations of main SoC to meet requirements for various kind of SoC, various range of CPU performance and many variations on the peripherals of IVI-HU.

(2) Open interface.

The AGL Reference Hardware should be open and public so that any user can use it for research and development of vehicle system. Any manufacturer can also use it for development and production. This feature encourages collaborative development which improves quality and functionality.

(3) Vehicle mountable

The AGL Reference Hardware should be built in vehicle system via 2DIN form factor and vehicle standard I/F. This feature enables to use environment close to real vehicle, which encourages advanced development, research and proposal.

## 2.4. Major feature

### 2.4.1. Selectable and Interchangeable architecture

It should have structure in which peripheral devices are selectable and interchangeable. It's realized by means of interchanging boards for each function (Figure 3). Each board which has specific functions should be selectable and interchangeable so that it can meet the requirements of the OEM.

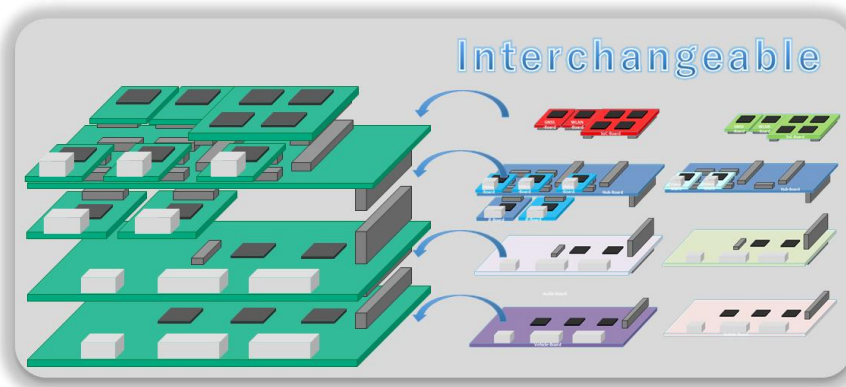

Figure 3 Selectable and Interchangeable architecture

### 2.4.2. Open Interface

It must have open interface to connect between the boards on the AGL Reference hardware. The interface is open and public interface so that any user can use it for research and development of vehicle system, and any manufacturer can use it for development and production.

### 2.4.3. Vehicle mountable structure

It must have structure which can be built in the vehicle. It must have form factor complaint to 2DIN (Figure 4).

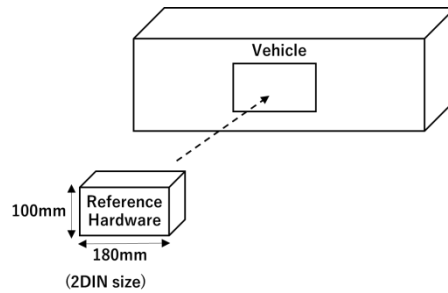

**Figure 4 Form Factor of the reference hardware (2DIN size)**

It must be able to connect vehicle system via vehicle data I/F (e.g. CAN, Ethernet, etc.) or vehicle power I/F (e.g. 12V).

It optionally has the enclosure around the Form Factor which can be hold inside vehicle by tighten screw (Figure 5), but it's just option because layout of screws is depend on each OEM.

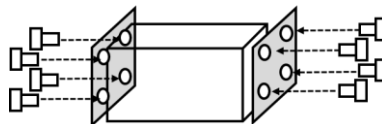

**Figure 5 The enclosure which can hold inside vehicle mounter by tighten screw**

## 2.5. Optional Feature

### 2.5.1. Selector

#### 2.5.1.1. AV control device

The AGL reference hardware optionally has abstraction mechanism called “selector” to control many Input / Output signals of Audio / Video devices. The Selector may be realized as one kind of the Selectable and Interchangeable board mentioned in 2.4.1.

An IVI Head Unit (HU) is connected with many peripheral devices which send or receive Audio / Video signals. However the number of Audio / Video signals is limited by the capability of System on a Chip (SoC). To connect more Audio / Video signals than SoC capability, IVI-Hus optionally has a specific module which controls Audio / Video signals in order to mediate the signals and SoC capability. The specific module is called AV Stream Controller whose entity may be Audio DSP, Video ASIC or any other device (Figure 6 left).

On the other hand, IVI-HUs may connect the peripheral devices and SoC directly (Figure 6 right).

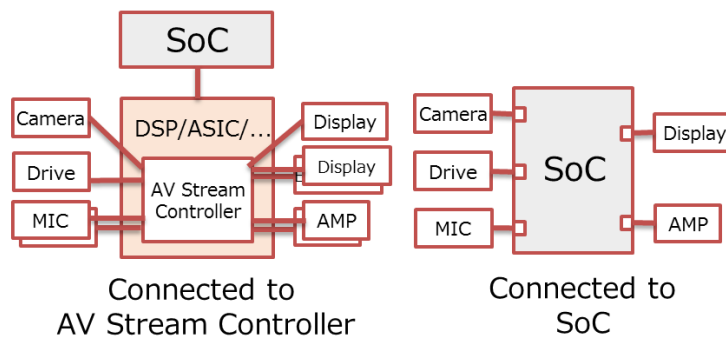

**Figure 6 Audio / Video signals connected to AV Stream Controller (left figure)  
or connected to SoC (right figure)**

In order to realize this, it optionally have abstraction mechanism called “Selector” (Figure 7).

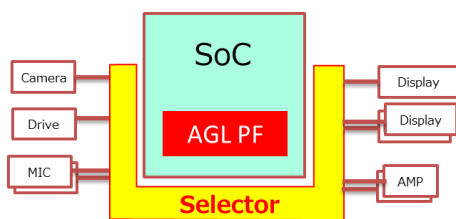
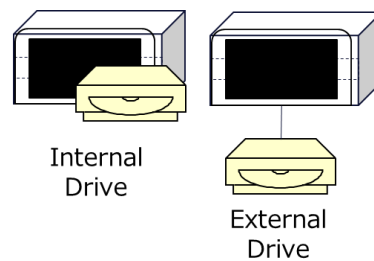

Figure 7 <T.B.D.> Abstraction mechanism called "Selector"

### 2.5.1.2. Location of peripheral devices

The AGL Reference hardware optionally has abstraction mechanism to support both peripheral devices of directly integrated into IVI-HU or separated from IVI-HU. It may be designed as one kind of the Selectable and Interchangeable board mentioned in 2.4.1.

Generally several peripheral devices are included in IVI system. And some of them (e.g. optical drive, tuner, display, etc.) may be integrated into IVI-HU or separated from IVI-HU. Thus AGL optionally support both compositions equivalently.



**Figure 8 Peripheral devices directory integrated into IVI-HU (left figure)  
or separated from IVI-HU (right figure)**

In order to realize it, Selector optionally has hardware abstraction mechanism. The mechanism may be realized in device drivers (Linux kernel layer) or Hardware Abstraction Layer (HAL).

### 3. AGL Reference Hardware requirements

Figure 9 shows basic structure of the AGL Reference Hardware.

The main feature is “Common I/F” which realizes Selectable and Interchangeable architecture (defined in section 3.1). The Common I/F should be open interface (defined in section 3.2). The structure should be vehicle mountable by 2DIN form factor (defined in section 3.3).

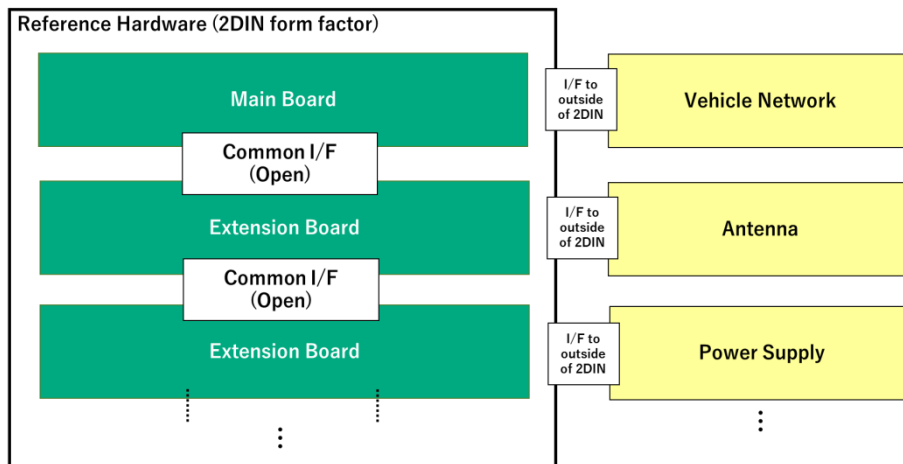

Figure 9 Basic structure of the AGL Reference Hardware

### 3.1. Selectable and Interchangeable Architecture

The Functions can be selectable and interchangeable by replacing the main or extension boards connected via Common I/F (Figure 10). This I/F has common design so that any hardware can be connected. To realize it, the Common I/F must have functionality and extensibility to cover OEM's various requirement.

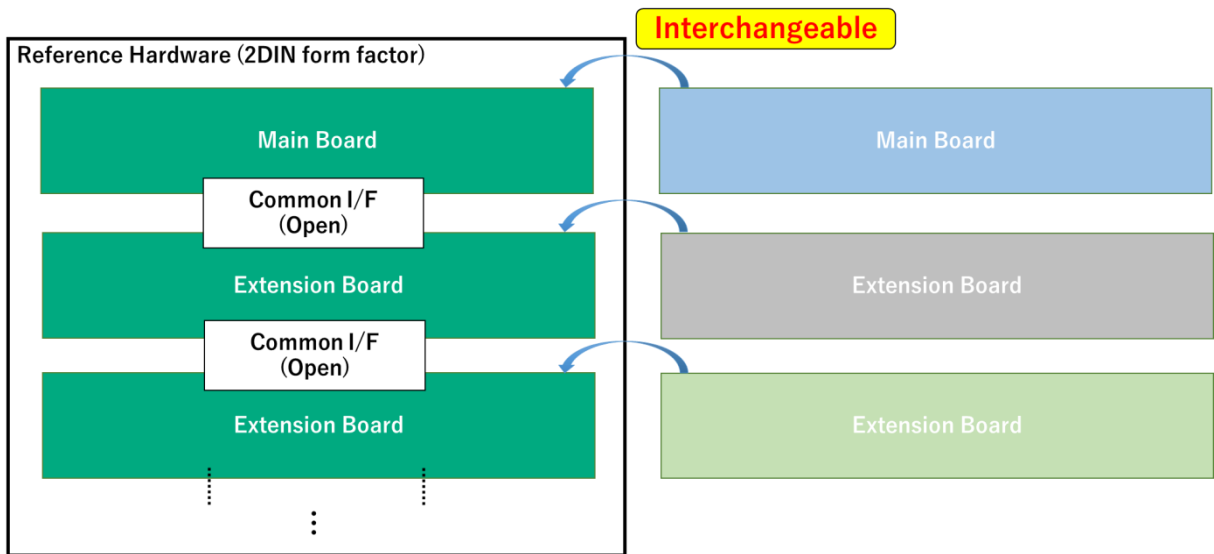

Figure 10 Selectable and Interchangeable Architecture



### **3.2. Open Interface**

The Common I/F should be open interface so that any user or any manufacturer can use it. By using it, anyone can add the new hardware and develop software on it.

### **3.3. Vehicle mountable structure**

It should have 2DIN form factor so that it can be mounted onto the vehicle.

## 4. Peripheral devices and functional requirements

### 4.1. Video / Audio input peripherals

IVI-HU receives video streams and/or audio streams from the peripherals.

#### 4.1.1. Camera

##### Use Case :

Front view camera, Rear view camera, Side view camera, In-Cabin camera etc.

- The image processing for surround view function is out of scope in this EG. (distortion correction, multi-viewpoint image composition, etc.) Other ECUs exterior to IVI-HU may take responsibility for surround view.

#### 4.1.2. Optical drive

##### Use Case :

Media Player (CD / DVD / BD)

- The difference of internal HU and external ECU is optionally absorbed by device driver layer / HAL.
- There are two types of allocations of decoding function. So AGL PF should have both of them as follows.

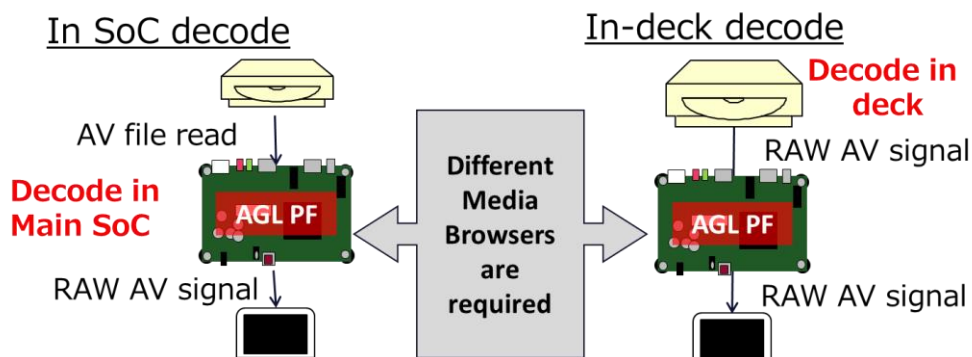

Figure 11 In SoC decode and In deck decode

### 4.1.3. Tuner

**Use Case :**

AM / FM radio, digital radio, digital TV, etc.

- The difference of internal HU and external ECU is optionally absorbed by device driver layer / HAL.
- In the case of supporting digital TV, not only audio stream but also video stream should be processed.

### 4.1.4. Microphone

**Use Case :**

Voice recognition, hands-free communication

- The difference of internal HU and external ECU is optionally absorbed by device driver layer / HAL.

## 4.2. Video / Audio output peripherals

IVI-HU sends video streams and/or audio streams to the peripherals. For the peripherals, the concept of Selector is required.

### 4.2.1. Display

**Use Case :**

Center information display (main / sub)

- It should support multiple displays.
- In the case of the touch panel displays, IVI-HU should receive the touch input signals from them.
- It should have I/F for connection to external display by the video cable with standard HDMI signal (Figure 12).

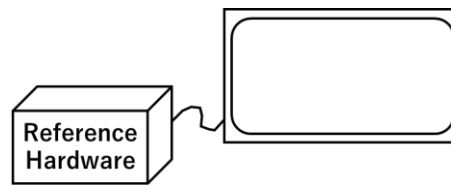

Figure 12 External display

- It optionally connect the display directory mount to the 2DIN form factor (Figure 13).

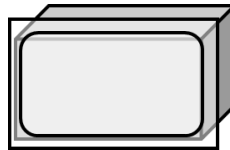

Figure 13 Directory mount display to 2DIN form factor

## 4.2.2. RSE

### Use Case :

Rear Seat Entertainment (RSE) System

- In regard to function allocation, two patterns of RSE should be supported.
  - (a) It should accept simple commands such as volume change.
    - It should be fully controlled from IVI-HU at front seat.
    - It should be similar to multiple displays from the IVI-HU's point of view.
  - (b) It should have individual GUI and provides all the functions but Video / Audio source. Equivalent to tablet devices.
- Unlike display / cluster / Head-Up Display (HUD), IVI-HU must provide not only Video output but also Audio output.
- It should support Multiple RSE.
  - So it should support multiple Video / Audio output streams.

## 4.2.3. Cluster / HUD

### Use Case :

Instrumental cluster, HUD, AR HUD

- In the current scope of Reference Hardware System Architecture Expert Group, Linux is not assumed as OS for cluster or HUD. So Virtualization (Hypervisor) is out of scope in this version of specification while more discussion about the topic is needed.
- It should support the function to send images and contents from IVI-HU to cluster / HUD. As an example, it optionally support surface sharing window system with other ECUs.

#### **4.2.4. AMP / Speaker**

**Use Case :**

Audio amplifier, speaker

- It should support multiple channels or multiple audio sink.
- The difference of internal HU and external ECU is optionally absorbed by device driver layer / HAL.

### **4.3. Data communication peripherals**

#### **4.3.1. Vehicle External Network devices**

The devices mentioned in this section treat the data communication with the outside vehicle such as mobile communication network, smartphone connection.

##### **4.3.1.1. DCM / TCU**

**Use Case :**

Communication with a network outside the car (e.g. mobile communication network)

- In regard to emergency call, it should support both compositions below.
  - (a) IVI-HU should take responsibility for calling (audio input / output).
  - (b) It should work in DCM (Data Communication Module) / TCU (Telematics Communication Unit).

#### **4.3.1.2. Wi-Fi / Bluetooth®**

**Use Case :**

Communication with the smartphone via wireless connection or communication with a network outside the car (Wi-Fi spot, etc.)

#### **4.3.1.3. USB**

**Use Case :**

Communication with the smartphone via USB

- In this connection, Video / Audio streams should be also processed as the data communication.

#### **4.3.1.4. ETC / DSRC**

**Use Case :**

V2X Communication

#### **4.3.1.5. NFC**

**Use Case :**

Driver identification with a smartphone, etc.

### **4.3.2. Vehicle Internal Network devices**

The devices mentioned in this section treat the information inside the vehicle except for the IVI-HU. There are various function allocations and various types of networks. For example, vehicle velocity signal may be analog signal of speed pulse or optionally be CAN signal through vehicle network. So vehicle data abstraction is required.

### **4.3.2.1. Vehicle Network**

**Use Case :**

Getting vehicle data from the vehicle networks

- It should support CAN as major vehicle bus.  
It should also support other vehicle networks. (CAN, CAN FD, LIN, etc.)

### **4.3.2.2. IVI Network**

**Use Case :**

Getting vehicle data from the vehicle networks

- In some vehicles, vehicle network and IVI network is optionally separated because of security, workload, and so on.  
It optionally supports various networks. (CAN, Ethernet, etc.)

### **4.3.2.3. Vehicle signal**

**Use Case :**

Getting vehicle data from the vehicle networks

- It optionally supports directly connected lines such as analog signal, serial connection, and so on.

## **4.4. Other peripherals**

### **4.4.1. Human Input devices**

**Use Case :**

User input of HMI (touch panel, touch pad, commander, steering switch, etc.)

- Some signals from these devices are optionally transmitted through vehicle internal network. (CAN, etc.)

#### **4.4.2. Navigation sensor**

**Use Case :**

Vehicle positioning

- It should support GPS / G / Gyro sensors.

#### **4.4.3. USB / SD (Media Storage)**

**Use Case :**

Media Player (USB memory, SD card)

- In these cases, Video / Audio streams should be decoded in SoC.



## **5. AGL software requirements**

### **5.1. AGL Latest Stable Release Support**

- Basic function of AGL Latest Stable Release should work on the AGL reference hardware.
- Not only device driver but also any layer of basic software as application, middleware and so on should work on it.
- Applicable version of AGL release should be defined in Reference Hardware Expert Group.

### **5.2. Selectable and Interchangeable architecture Support**

- It should support Selectable and Interchangeable architecture mentioned in section3.
- It should have device driver and other layer software working on SoC to control any peripherals on the AGL reference hardware.

### **5.3. Selector Support**

- It optionally supports Selector mentioned in the section 2.5.
- It optionally collaborates with the User Interface and Graphics Expert Group. (Related to Audio routing, etc.)

### **5.4. Vehicle Data Abstraction**

- It optionally supports the mechanism of vehicle data abstraction to absorb the variation of OEMs as mentioned in the section 4.3.2,.
- It optionally collaborates with the Connectivity Expert Group. (Related to vehicle data)

## **5.5. Cluster / HUD Support**

- It optionally supports cluster / HUD, the function of sending images and contents from IVI-HU.
- It optionally collaborates with the User Interface and Graphics Expert Group.  
(Related to multiple ECUs)

## 6. Notices

Linux is a registered trademark of Linus Torvalds.

Bluetooth® is a registered trademark of Bluetooth SIG Inc.

Blu-ray Disc is a registered trademark of the Blu-ray Disc Association.

Wi-Fi is a registered mark of the Wi-Fi Alliance.